

ORGANIZZAZIONE
ORLANDELLI



1

CATALOGUE

BANCALI ESPOSITORI
DISPLAYING TABLES

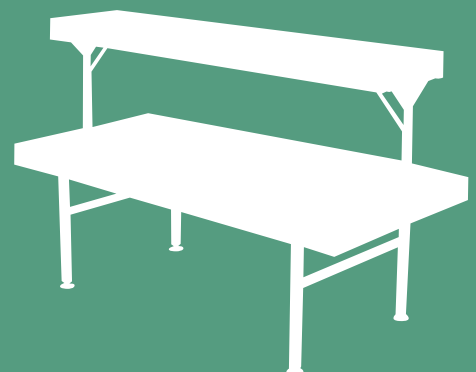

1983 / 2013

TRENT'ANNI DI PASSIONE



La grande Passione per il settore della Floricoltura ha caratterizzato i primi 30 anni di attività di Organizzazione Orlandelli e sarà la stessa Passione a muovere la nostra determinazione con cui affronteremo le sfide di domani.

Ogni giorno la Famiglia e lo Staff dell'Azienda si interfaccia in modo serio e professionale con l'intera filiera Floricola offrendo sempre le migliori soluzioni per la movimentazione ed esposizione di piante e fiori. Ad oggi, con i nostri prodotti ed i nostri servizi, abbiamo affiancato alcuni tra i più bei Garden Centre, efficienti Home Centre e aziende Floricole di tutto il mondo.

Oltre alla Passione, alla serietà e alla trasparenza nei rapporti, il valore aggiunto della nostra Azienda è la competenza nel settore della Floricoltura che passa anche dalla sinergia tra le altre Aziende del Gruppo Orlandelli che includono: Garden Centre Valle dei Fiori, Azienda Agricola Orlandelli Ugo, Landscaping Giardini Valle dei Fiori e l'Azienda di consulenza Entergreen. Le esigenze di chi opera nel settore della Floricoltura trovano un ambiente di lavoro comune con chi progetta e realizza soluzioni ; questa quotidiana sinergia rende il nostro Gruppo unico ed inimitabile e ci permette di offrire prodotti altrettanto unici, pratici ed innovativi.

La nostra ambizione è diventare il principale punto di riferimento professionalmente preparato che, con serietà e tanta passione, in un mercato competitivo, asseconda con successo le richieste di una clientela sempre più esigente, proponendo soluzioni standard o personalizzate, efficaci ed efficienti, attraverso attività ecologicamente e socialmente responsabili.



EQUIPMENT FOR
FLORICULTURE
FIELD



GARDEN
CENTRE



CONSULTING
COMPANY



LANDSCAPING



AMERICAN
DEPARTMENT



GROWER

30
1983 / 2013

30 YEARS PASSION

The great passion for the Floriculture industry has characterized the first 30 years of Organizzazione Orlandelli and the same passion and determination will lead us to face the challenges of tomorrow. With this background, the Family and Staff of the Company interface seriously and professionally the entire Horticultural supply chain offering the best solutions for transportation and displaying of plants and flowers. Today, with our products and services, we have partnered some of the most beautiful Garden Centres, most efficient Home Centres and some of the biggest Growers, all around the world.

Besides the strong passion, trustworthiness and transparency, the added value of our Company is the deep Floricultural expertise, result from the synergy between the Companies in the Orlandelli Group: The Garden Centre Valle dei Fiori, Ugo Orlandelli Nursery, the Landscaping Company Giardini Valle dei Fiori and the Entergreen consulting firm. The operators in the Floricultural sector need complete solutions for their business from designs to the final implementation of the projects. The synergy between our companies makes this possible and our Group unique, inimitable and allows us to offer equally unique, practical and innovative products.

Our ambition is to become the main reference for professional operators in a competitive market. We aim to successfully satisfy every requirement facing all the demands with standard, tailor made or custom solutions, effectively and efficiently, through environmentally and socially responsible activities.

Abbiamo rivoluzionato il BANCALE PER L'ESPOSIZIONE DI PIANTE E FIORI unendo ad un design essenziale, tecniche di imballo e assemblaggio innovative che riducono decisamente i costi.

We have revolutionised the BENCH FOR DISPLAYING OF POT PLANTS AND FLOWERS combining to the essential design, packaging and assembly techniques that radically reduce labor costs.

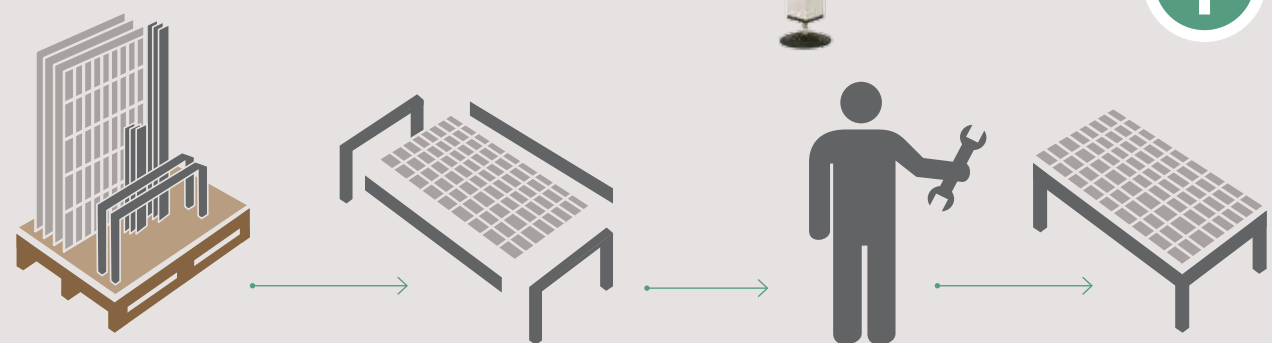

SMART PACKAGING

MONTAGGIO FAI DA TE DIY ASSEMBLY

ARTICOLO ITEM	DIMENSIONI DIMENSIONS	PZ / PCS	H 350 mm	H 550 mm	H 750 mm
COD. 5L1S0310252055	1.025 x 2.055 mm	10	6	2	2
COD. 5L2S0310252055		20	12	4	4
COD. 5L1S0312252530	1.225 x 2.530 mm	10	6	2	2
COD. 5L2S0312252530		20	12	4	4
COD. 5L070116253030	1.625 x 3.030 mm	10	-	-	10
		20	-	-	20
COD. 5L070116253530	1.625 x 3.530 mm	10	-	-	10
		20	-	-	20

Altre misure su richiesta
Other dimensions on demand

IL BANCALE LOW COST

Ideale per l'esposizione di piante e fiori, adatto ad ambienti interni ed esterni, robusto e maneggevole. Realizzato con profili in lega primaria di alluminio e caratterizzato da ottime finiture con angoli arrotondati protegge spigoli. Il bancale LOW COST da assemblare, apprezzato da clienti di tutto il mondo, è stato creato da Organizzazione Orlandelli per assecondare le esigenze di coloro che richiedono bancali con ottime finiture, ma a prezzi contenuti. I profili di alluminio già preforati verranno assemblati in modo SEMPLICE e VELOCE direttamente dal cliente utilizzando viti e rivetti in dotazione. In questo modo si mantiene l'alto valore estetico e la stessa robustezza del bancale saldato, il tutto a vantaggio di un risparmio economico sia sul prodotto che sulle spese di trasporto.

It's Ideal for displaying of all pot plants and flowers, suitable for interior and exterior environments, strong made, long lasting and easy to handle. Realized with profiles in primary aluminum alloy with excellent finishes such as rounded corners and protected edges. To meet the needs of those who require quality benches for affordable prices, Organizzazione Orlandelli has developed a product appreciated by customers all over the world, the LOW COST and ready to assemble bench. The aluminum profiles, pre drilled, will be assembled QUICKLY and EASILY by the customer using the supplied screws and rivets. This new concept maintains the high aesthetic value and the strength of welded benches with the benefit of a cost savings both on the product and on the transportation cost.

CARATTERISTICHE

Il ripiano in polistirene di cui sono corredati i bancali, è ad alta resistenza ai raggi UV ed antiriflesso con un'altezza di 65 mm ed è completo di filtro e rubinetto di scarico. Le grecature che lo caratterizzano evitano il ristagno dell'acqua e lo rendono adatto anche ad irrigazione con impianti flusso e riflusso. I traversini di supporto della vasca sono disposti in modo da garantire una portata di carico fino a 70 kg/mq. Il bancale è corredato da tiranti. I cavalletti sono realizzati con tubolare in alluminio 40x40x2mm ed hanno un'altezza di 650mm, ai quali

vanno applicati piedini snodabili Ø 80 mm, oppure su richiesta, un kit ruote (4 girevoli di cui 2 autobloccanti Ø 100 mm)

FEATURES

The polystyrene trays are UV highly resistant and anti reflective, 65 mm high and complete with filter and discharge cock. The drains avoid the stagnation of water and make it suitable for irrigation ebb and flow. The cross pieces supports are arranged in such a way to ensure a load capacity up to 70 kg/m2. The Bench comes with guyed. The Trestles are made of aluminum tubular, 40x40x2mm, and have a height of 650 mm. Adjustable feet Ø 80 mm or, on request, a sets of wheels (4 swiveling wheels of which 2 swivel casters self-locking)

BANCALE IN ALLUMINIO LOW COST

Vasca con fondo a tenuta ermetica in polistirene, struttura in lega primaria d'alluminio preforata da assemblare, supporto fisso con piedino regolabile Ø 80 mm, rubinetto di scarico, filtro.

.en LOW COST ALUMINIUM BENCH

Polystyrene hermetic basin, structure in pre drilled aluminum frames ready to be assembled, fix legs with adjustable feet Ø 80 mm, drain-cock, filter.

.fr BANC EN ALUMINIUM LOW COST

Fermeture Étanche du fond du bac en polystyrene structure en alliage préforé d'aluminium d'assembler, support fixe avec le petit pied réglable diam. 80 mm, purgeur d'écoulement, filtre.

.de ALUMINIUM VERKAUFSTISCHE LOW COST

Polystyrol Wasserwanne, vorgebohrte Aluminiumlegierung Struktur zum Montieren, festes Gestell mit regulierbaren Füßchen Ø 80 mm, Filter und Ablasshahn.

.es MESA DE ALUMINIO LOW COST

Bañera con reserva de agua con fondo de polystyrene cerrada herméticamente. Estructura de aluminio perforado, para ser ensambladas, altura fija, con pies ajustables Ø 80 mm, grifo y filtro.

TUTTI I BANCALI SONO COSTRUITI PER GARANTIRE LA MASSIMA TENUTA, ROBUSTEZZA E DURATA NEL TEMPO.

ALL BENCHES ARE MADE TO GUARANTEE THE MAXIMUM CAPACITY, STRENGTH AND LONG LIFE.



COD. 5L070116253530

BANCALE IN ALLUMINIO LOW COST

Vasca con fondo a tenuta ermetica in polistirene, struttura in lega primaria d'alluminio preforata da assemblare, supporto fisso con piedino regolabile Ø 80 mm, rubinetto di scarico, filtro.

.en LOW COST ALUMINIUM BENCH

Polystyrene hermetic basin, structure in pre drilled aluminum frames ready to be assembled, fix legs with adjustable feet Ø 80 mm, drain valve, filter.

.fr BANC EN ALUMINIUM LOW COST

Fermeture Étanche du fond du bac en polystyrene structure en alliage préforé d'aluminium d'assembler, support fixe avec le petit pied réglable diam. 80 mm, purgeur d'écoulement, filtre.

.de ALUMINIUM VERKAUFSTISCHE LOW COST

Polystyrol Wasserwanne, vorgebohrte Aluminiumlegierung Struktur zum Montieren, festes Gestell mit regulierbaren Füßchen Ø 80 mm, Filter und Ablasshahn.

.es MESA DE ALUMINIO LOW COST

Bañera con reserva de agua con fondo de polystyrene cerrada herméticamente. Estructura de aluminio perforado, para ser ensambladas, altura fija, con pies ajustables Ø 80 mm, grifo y filtro.

HHH

THREE HEIGHTS

VISIONE COMPETENTE

Esporre su diverse altezze esalta la bellezza delle piante e rende gli ambienti più dinamici.

COMPETENT VISION

Exhibit on different heights to enhance the beauty of the plants and create more dynamic environments.



VANTAGGI DELLE 3 ALTEZZE ADVANTAGES OF THREE HEIGHTS



L'esposizione su diverse altezze è in grado di valorizzare al meglio le piante esposte. Essendo esse di altezze diverse e forme diverse, la cosa corretta da fare è quella di posizionare la pianta sul bancale che ha un'altezza ideale per il tipo di pianta da esporre. Facendo un'analisi molto semplice e veloce la collocazione delle piante potrà essere molto più visibile su banchali bassi per piante alte (Hortensie, Spathiphyllum, Kenzie, ecc.), su banchali alti per piante basse (Primule, Viole, Kalanchoe, ecc.). Inoltre giocando con gli effetti cromatici dei fiori si riesce ad ottenere il massimo della dinamicità e della creatività. Ecco perché è stata decisa la produzione di banchali in set da 10 o 20 pezzi, costituiti da 3 varie altezze (350 mm e 750 mm) per permettere ai nostri clienti di esporre il proprio prodotto in modo corretto e soprattutto professionale.

The 3 heights exhibition adds value to the products. The plants are of different heights and should be displayed on the benches that have the right characteristics. High plants are more visible on low benches (Hortensia, Spathiphyllum, Kentzia, etc.). Smaller plants, such as Primulas, Perennials, Kalanchoe, etc., are better visible on high benches. Besides, playing with the chromatics effect of the flowers, the result of the hybrid displaying will create a dynamic and vibrant show. This last is one of the reasons why the benches are offered in set of 10 or 20 pieces and consisting of 3 strategic heights (350 mm, 550 mm and 750 mm) that allow exhibiting every product in a professional way.





IL BANCALE IN ALLUMINIO

Ideale per l'esposizione di piante e fiori, adatto ad ambienti interni ed esterni, robusto e maneggevole.

Ideal for displaying of all kind of pot plants and flowers, suitable for Interior and exterior environments, strong, long lasting and easy to handle.

CARATTERISTICHE

Realizzato con profili in lega primaria di alluminio, saldato a TIG e caratterizzato da ottime finiture, tra le quali angolari arrotondati proteggi spigoli. Il supporto è telescopico ed è possibile, grazie a un sistema a scatto, variarne l'altezza da mm 550 a mm 750 con una semplice pressione. Il ripiano in polistirene, posto all'interno del bancale, è ad alta resistenza ai raggi UV ed antiriflesso con un'altezza di 65 mm ed è completo di filtro e rubinetto di scarico. Le grecature che lo caratterizzano evitano il ristagno dell'acqua e lo rendono adatto anche a sistemi di irrigazione "flusso e riflusso". I traversini di supporto della vasca sono disposti in modo da garantire una portata di carico fino a 70 kg/mq.

FEATURES

Created with profiles in primary aluminum alloy, TIG welded with excellent finishes, including rounded corners and protected edges. The telescopic support is easy to operate thanks to a release system. With a simple pressure it's possible to change the height from 550 mm to 750 mm. The Polystyrene tray is UV resistant and anti reflecting. 65 mm high, complete with filter and discharge cock. The drains avoid the stagnation of water and make it suitable for irrigation ebb and flow. The cross pieces supports are arranged in such a way to ensure a load capacity up to 70 kg/m2.

BANCALE IN ALLUMINIO

Vasca con fondo a tenuta ermetica in polistirene, struttura in lega primaria d'alluminio saldata a TIG, supporto telescopico da 550/750 mm, rubinetto di scarico, filtro, 4 ruote girevoli di cui 2 autobloccanti, Ø 100 mm.

.en ALUMINIUM BENCH

Polystyrene Hermetic basin. Structure in primary aluminum alloy, TIG welded. Telescopic supports 550/750 mm, drain valve, filter. 4 swiveling wheels of which 2 swivel casters self-locking, Ø 100 mm

.fr BANC EN ALUMINIUM

Fermeture Étanche du fond du bac en polystyrene structure en alliage d'aluminium soudé a TIG, télescopique support 550/750 mm, purgeur d'écoulement, filtre, 4 roues pivotantes de 2 verrouillage, Ø 100 mm.

.de ALUMINIUM VERKAUFSTISCHE

Polystyrol Wasserwanne, TIG geschweißte Aluminiumlegierung Struktur, höhenverstellbares Gestell 550/750 mm, Ablasshahn, Filter, 4 drehbare Rollen, 2 von den mit Bremse Ø100 mm

.es MESA DE ALUMINIO

Bañera con reserva de agua con fondo de polystyrene cerrada herméticamente, soporte telescópico, desagüe + filtro, 4 ruedas giratorias con 2 ruedas autoblocantes Ø 100 mm



MIN H 550 mm

MAX H 750 mm

ALTEZZA REGOLABILE
ADDITIONAL ADJUSTABLE HEIGHTS

MISURE DISPONIBILI / AVAILABLE DIMENSIONS	
COD. 500010252055	1025 X 2055 mm
COD. 500012252530	1225 X 2530 mm

Altre misure su richiesta
Other dimensions on demand



€ / m²

Ottimizzare ed abbellire in modo intelligente gli spazi espositivi aumentando la quantità di merce esposta per ogni metro quadrato.

Optimize and beautify the exhibition areas increasing the amount of showed items per square meter.

A

ACCESSORI
ACCESSORIES



BANCALE IN ALLUMINIO RIALZATO

Realizzato con profili in lega di alluminio, saldati a TIG e caratterizzati da ottime finiture, tra le quali angolari arrotondati proteggi spigoli. Vasca con fondo a tenuta ermetica in polistirene, rubinetto di scarico.

.en ALUMINIUM RAISED BENCH

Made of primary aluminum alloy profiles, TIG welded with excellent finishes, including rounded corners and protected edges. Polystyrene Hermetic basins, drain valve.

.fr BAC EN ALUMINIUM SURMONTÉ

Composé de profilés en alliage d'aluminium, soudé au TIG et disposent d'une excellente finition, y compris les protections d'angles des bords arrondis. Fermeture étanche du fond du bac en polystyrène, purgeur d'écoulement.

.de ERHOBENER ALUMINIUM VERKAUFSTISCH

Hergestellt aus TIG geschweißten und feinbearbeiteten Aluminium-Legierung Profilen, mit abgerundeten Kantenschutzecken. Ebbe-Flut Wasserwanne aus Polystyrol, Ablassventil.

.es MESA DE ALLUMINIO SUPERIOR

Fabricado de perfiles de aleación de aluminio, soldadura TIG y cuentan con excelentes acabados, incluyendo protectores de esquinas bordes redondeados. Banera con reserva de agua con fondo de polystireno, desagüe.

ARTICOLO ITEM	BANCALE BENCHES	DIMENSIONI DIMENSIONS
COD. 500R0003B005	1025 x 2055 mm	465 x 2075 mm
COD. 500R0005B008	1225 x 2530 mm	656 X 2545 mm



DETTAGLI E OPTIONAL PER BANCALI LOW COST E SALDATI DETAILS AND OPTIONALS FOR LOW COST AND WELDED BENCHES

DETTAGLI DETAILS

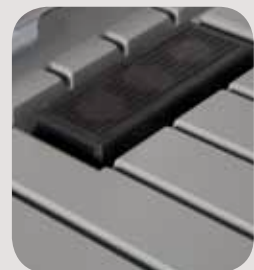

FILTRO
FILTER

RUBINETTO
DRAIN-COCK

OPTIONAL



PANNO
UMIDIFICATORE
HUMIDIFYING
MEMBRANE

IRRIGAZIONE
FLUSSO-RIFLUSSO
IRRIGATION
EBB/FLOW

VALVOLA
VALVE

VISUAL MERCHANDISING





VISUAL MERCHANDISING



UNA SOLUZIONE PRATICA, DAL DESIGN MODERNO, PER ESPORRE E VENDERE LE PIANTE IN BASKET

A PRACTICAL SOLUTION WITH A MODERN DESIGN, TO DISPLAY BASKETS



PARTICOLARI PARTICULARS



TUBOLARE PER AGGANCIO
TUBULAR FOR HOOKING

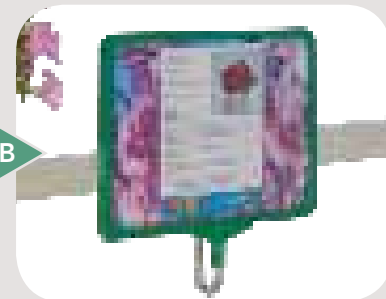

PORTAPREZZI (SU RICHIESTA)
PRICE HOLDER (ON DEMAND)

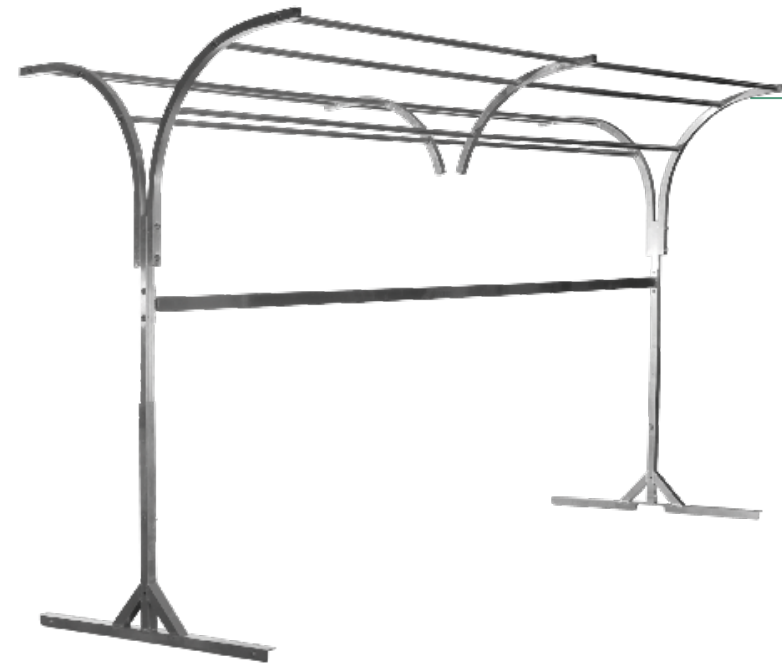

PORTA BASKET

Struttura in alluminio porta basket ad arco per banchali, dotato di sistema anti-ribaltamento e regolabile su 3 livelli di altezza (1.360/1.760 mm rispetto al ripiano del bancale).

.en BASKET HOLDER
Bowed in aluminium basket holder for benches, supplied of an anticapsizing system and adjustable on 3 heights levels (1.360/1.760 mm from the bench level).

.fr PORTEPANIER
Arqué en aluminium pour les bancs, fourni d'un système anti-chavirement et réglable sur 3 niveaux d'hauteur (1.360/1.760 mm du fond du banc).

.de TISCHAMPELAUFSATZ
Gebogener Alu-Tischampelaufsatz für Aluminium-Verkaufstische, mit Anti-Überschlagsystem. 3 Höhenverstellungen (1.360/1.760 mm von der Ebene des Tisches).

.es APOYO PARA CANASTAS
Estructura en aluminio apoya-canastas a forma de arco para mesas, con antivuelco y ajustable en 3 niveles de altura (1.360/1.760 mm desde la bañera) con asta para preciso.

ARTICOLO ITEM	BANCALE BENCHES	ALTEZZA HEIGHT
COD. 54P3A000B005	1025 x 2055 mm	min 1.360 max 1.760 mm
COD. 54P3A000B007	1225 x 2530 mm	min 1.360 max 1.760 mm

COD. 54SEH370B005

SEPARATORE ANTICADUTA IN ALLUMINIO
ANTICAPSIZING ALUMINIUM SEPARATOR





GRADONE

Espositore a 2 ripiani. Struttura tubolare in alluminio con ripiani in legno listellare a tre strati certificato PEFC, piedini regolabili.

.en STAIR-STEP DISPLAYER

2 shelves display. Aluminum tubular frame with three-layer wooden shelves, PEFC certificate, adjustable feet.

.fr GRADIN

Presentoir a 2 étagères. Aluminium tubulaire structure avec les étagères en bois lamellaire certifié PEFC a 3 couches, petit pieds réglables.

.de STUFIGES-VERKAUFSSTÄNDER

Zweistufiges Verkaufsständer. Aluminiumstruktur mit drei-Schicht PEFC zertifizierten Holzregalen, verstellbare Füßchen.

.es GRADONE

Aluminio expositor con 2 estantes. Marco de aluminio tubular con estantes de madera laminada de tres capas con certificación PEFC, pies regulables.



MISURE DISPONIBILI / AVAILABLE DIMENSIONS

COD. 54EG000G1025	1025 X 620 X H 575 mm
COD. 54EG000G1225	1225 X 620 X H 575 mm
COD. 54EG000G1625	1625 X 620 X H 575 mm



Kg 11,50
m³ 0,06



Kg 13,00
m³ 0,06



Kg 18,00
m³ 0,08

COD. 54PCV040VC12 PORTA CONCIME

Vassoio porta concime in lamiera verniciata a polvere verde con porta prezzi formato A4. Ideale per l'esposizione di concimi. L 405 P 405 H 1230 mm

.en FERTILITER HOLDER

Iron tray powder-coated green varnished, with A4 price/sheet holder. It's Ideal for displaying of fertilizers or similar. L 405 W 405 H 1230 mm

.fr PORTE ENGRAIS

Plateau en tôle verni en poudre vert avec cadre pour les prix dim. UNI A4. Idéal pour exposer les engrais. L. 405 l 405 H 1230 mm.

.de DÜNGEMITTEL-BEHÄLTER

Düngemittel-Behälter mit grünen pulverbeschichteten Blech mit Preisschild Format UNI A4. Sorg für eine ideale Düngemittelpräsentation. L 405 B 405 H 1230 mm.

.es ABONO FERTILIZANTE

Puerto hojas, bandeja de puerta con recubrimiento de polvo, con velocidades de cuadro puertas UNI A4 297 x 210 mm. Ideal para la visualización de los fertilizantes en mesas de aluminio. L 405 AN 405 AL 1230 mm.



Kg 5,00
m³ 0,03

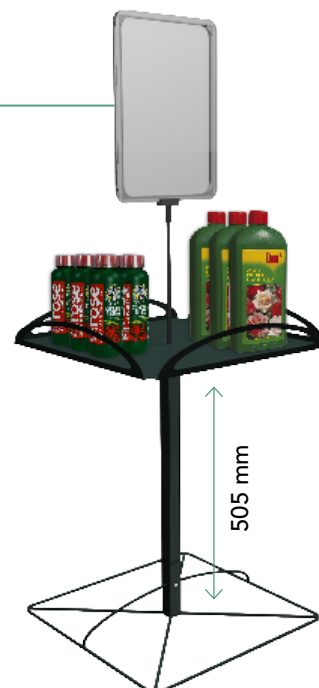

CORNICE PORTAPREZZI

Piantana regolabile verniciata con cornice portaprezzi colore verde e PVC trasparente proteggi grafica. Formato UNI A4 297 x 210 mm.

.en PRICE HOLDER

Adjustable holder. Green painted price holders' frame with transparent PVC graphic protection, UNI format A4 297 x 210 mm.

.fr CADRE PORTE TARIFICATION

Support réglable peint avec le cadre vert pour les prix et pvc transparent protège graphique. Dim. UNI A4 297 x 210 mm

.de PREISSCHILDER

Lackiertes höhenverstellbares Gestell mit grünem Preisschild und PVC transparenter Graphikschützung. Format UNI A4 297 x 210 mm.

.es MARCO DATASTRIPS

Marco pintado piso ajustable con soporte PVC precio verde claro y proteger gráficos. Formato A4 297 mm x 210.



COD. B49044V
H MIN 330 mm
MAX 510 mm



COD. B49045V
H MIN 865 mm
MAX 1330 mm



DISPLAY PORTA GRAFICHE PER BANCALI

Struttura in lamiera verniciata verde, regolabile in due posizioni. Ideale per valorizzare le piante esposte su bancali. Utilizzabile anche come porta prezzi.

.en GRAPHICS DISPLAY for BENCHES

Metal structure, green painted, adjustable in two positions. It's Ideal for enhancing the exposed plants. Also suitable as price holder

.fr SUPPORT GRAPHIQUE POUR LES BANCS

Structure en feuille verni en poudre. Moyen idéal pour améliorer les plantes exposées sur les bancs. On peut utiliser aussi pour le tarification des prix.

.de WERBETAFEL DISPLAY FÜR VERKAUFTISCHE

Grün lackierte Blechstruktur, regulierbar auf zwei Positionen. Perfekt um die auf die Verkaufstische ausgestellte Pflanzen aufzuwerten. Benutzbar auch als Preisschild.

.es MOSTRAR PORTAGRAFICHE

Chapa pintada de color verde, regulable en dos posiciones. Ideal para la mejora de las plantas expuestas en mesas. También se puede utilizar como precios de puerta.

ARTICOLO ITEM	DIMENSIONI DIMENSIONS
COD. 54PGS005V012	L 1025 mm
COD. 54PGS006V012	L 2055 mm
COD. 54PGS0A3V012	L 420 mm (A3)

Altre misure su richiesta
Other dimensions on demand

PARTICOLARI PARTICULARS

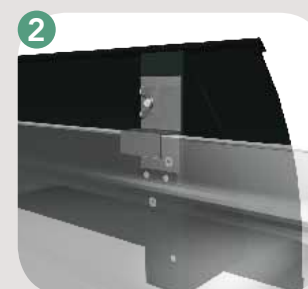

GRAFICHE INTERCAMBIABILI
INTERCHANGEABLE GRAPHICS

AGGANCIAMENTO REGOLABILE
IN DUE POSIZIONI 1 2
ADJUSTABLE ON 2
POSITION 1 2



COD. 508508502525

BANCALE IN ALLUMINIO

Espositore multipiano della gamma bancali con vasca a tenuta ermetica in polistirene, struttura in lega d'alluminio saldata a TIG, rubinetto di scarico 4 ruote girevoli Ø 100 mm di cui 2 autobloccanti. Ultimo ripiano inclinabile a due posizioni. L 2.525 P 850 H 1.500 mm

.en ALUMINIUM BENCH

Multi-storey Display, Polystyrene Hermetic basins, drain valve. Made of primary aluminum alloy profiles, 4 swiveling castors Ø 100 mm of which 2 self-locking. The top shelf is adjustable, two position. L 850 W 2.525 H 1.500 mm

.fr BANC EN ALUMINIUM

Fermeture étanche du fond du bac en polystyrène, structure en alliage d'aluminium, purgeur d'écoulement, 4 roues pivotantes Ø 100 mm de 2 verrouillage. Dernière étagère inclinable. L 2.525 l 850 H 1.500 mm

.de ALUMINIUM - VERKAUFSTISCH

3-stufiger Regalständer. Polystyrol Einsatzwanne mit Wasserdicht, Struktur aus Alulegierung, Ablasshahn, mit 4 drehbaren Rollen Ø 100 mm, 2 von den mit Bremse. Die letzte Etage ist zurückklappbar. L 2.525 B 850 H 1.500 mm

.es MESA DE ALUMINIO

Reserva de agua de polystirene cerrada herméticamente, desagüe, 4 ruedas giratorias Ø 100 mm con 2 autobloccantes. Último descansillos reclinables. L 2.525 AN 850 AL 1.500 mm

Kg 43,00
m³ 1,65

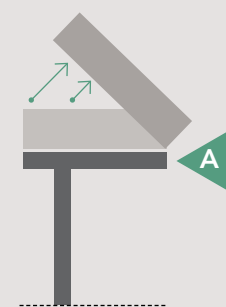
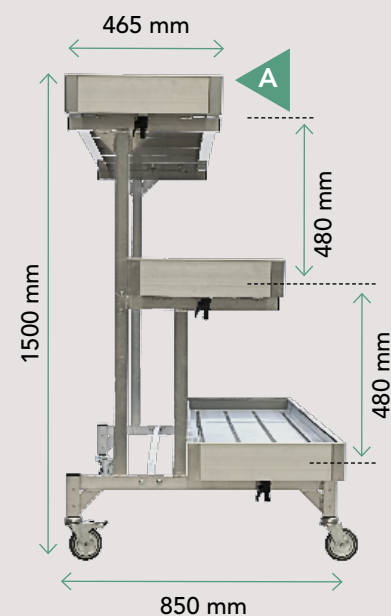

ULTIMO RIPIANO INCLINABILE
LAST RECLINABLE SHELF



COD. 503S13802065

BANCALE A ISOLA

Espositore multipiano della gamma bancali, con vasca a tenuta ermetica in polistirene, struttura in lega d'alluminio saldata a TIG, rubinetto di scarico, 4 ruote girevoli di cui 2 autobloccanti Ø 100 mm. L 2065 P 1380 H 900 mm. Misure dei ripiani: N°2 da 2055x465 mm - N°1 da 2066x 825 mm

.en ISLAND BENCH

Multi-story table display with polystyrene hermetic basins, aluminum frame TIG welded, drain valve, 4 swiveling wheels of which 2 swivel casters self-locking, Ø 100 mm. L 2065 W 1380 H 900 mm. Shelf measures: N° 2 from 2055x465 mm-N° 1 from 2066x 825 mm

.fr PRESENTOIR A ILE

Presentoir à plusieurs étages de la gamme du bacs avec fermeture étanche du fond du bac en polystyrène, structure en alliage d'aluminium soudé a TIG, purgeur d'écoulement 4 roues pivotantes de 2 verrouillage, Ø 100 mm. L 2065 l 1380 H 900 mm - Dimensions des étagères: N. 2 mm 2055 x 465 - N. 1 mm 2066 x 825 mm

.de INSEL-VERKAUFSTISCH

Etagen-Verkaufständer von der selber Produktpalette der Verkaufstische, mit Polystyrol Wasserwannen, TIG geschweißte Aluminiumlegierung Struktur, Ablasshahn, 4drehbare Rollen, 2 von den mit Bremse Ø100 mm. L 2065 B 1380 H 900 mm. Größe der Etagen: N°2 - 2055x465 mm - N°1 - 2066x 825 mm

.es EXPOSITORES ISLA

Expositor en aluminio con reserva de agua con fondo de polystirene, cerrada herméticamente, estructura de aleación de aluminio, desagüe, 4 ruedas giratorias con 2 autobloccantes, Ø100 mm. L 2065 AN 1380 AL 900 mm. Medidas rellanos: N°2 - 2055x465 mm - N°1 - 2066x 825 mm



OPTIONAL

COD. 54P3A000B004
PORTA BASKET
BASKET HOLDER

PROGETTI PERSONALIZZATI
A RICHIESTA
CUSTOMIZABLE PROJECTS
ON DEMAND



DETTAGLI DETAILS



RUBINETTO
DRAIN-COCK

OPTIONAL



PANNO UMIDIFICATORE
HUMIDIFYING MEMBRANE

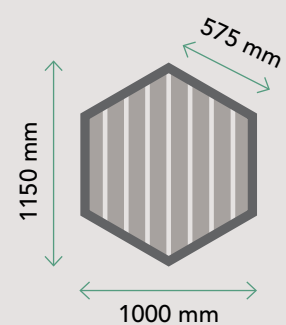

COD. 507010001150
BANCALE ESAGONALE

Vasca in ABS, struttura in lega primaria d'alluminio saldata a TIG, supporto telescopico da 550/750 mm, rubinetto di scarico, 4 ruote girevoli di cui 2 autobloccanti, Ø 100 mm.

.en HEXAGONAL BENCH
ABS basin, structure made of aluminum primary alloy, TIG welded. Telescopic support 550/750 mm, drain valve, 4 swiveling wheels of which 2 swivel casters self-locking, Ø 100 mm

.fr BANQUETTE HEXAGONALE
Bac en ABS, structure en aluminium soudé a TIG, support réglable de 550/750 mm. Purgeur d'écoulement, n. 4 roues pivotantes de 2 verrouillage, Ø 100 mm.

.de SECHSECKIGER VERKAUFSTISCH
ABS Wanne, TIG geschweißte Aluminium-Legierung Struktur, höhenverstellbares Gestell 550/750 mm, Ablasshahn, 4 drehbare Rollen, 2 von den mit Bremse Ø 100 mm

.es MESA EXAGONAL
Mesa en ABS, estructura en aluminio, desagüe de descarga, 4 ruedas giratorias con 2 ruedas autobloccantes Ø 100 mm





VISUAL MERCHANDISING



MIN H 550 mm

MAX H 750 mm

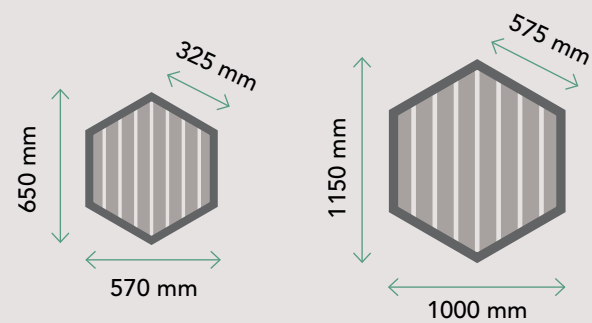

ULTERIORI FORME SU RICHIESTA OTHER SHAPES ON DEMAND



COD. 507210001150
BANCALE ESAGONALE 2 RIPIANI

Vasca in ABS, struttura in lega primaria d'alluminio saldata a TIG, supporto telescopico da 550/750 mm, rubinetto di scarico, 4 ruote girevoli di cui 2 autobloccanti Ø 100 mm.

.en 2 SHELVES HEXAGONAL BENCH

ABS basin, structure made of aluminum primary alloy, TIG welded. Telescopic support 550/750 mm, drain valve, 4 swiveling wheels of which 2 swivel casters self-locking, Ø 100 mm

.fr BANQUETTE HEXAGONALE A 2 ÉTAGERES

Bac en ABS, structure en aluminium soudé a TIG, support réglable de 550/750 mm. Purgeur d'écoulement, n. 4 roues pivotantes de 2 verrouillage, Ø 100 mm.

.de 2-STUFIGER SECHSECKIGER VERKAUFSTISCH

ABS Wanne, TIG geschweißte Aluminium-Legierung Struktur, höhenverstellbares Gestell 550/750 mm, Ablasshahn, 4 drehbare Rollen, 2 von den mit Bremse Ø 100 mm

.es MESA EXAGONAL 2 RELLANOS

Mesa en ABS, estructura en aluminio, desagüe de descarga, 4 ruedas giratorias con 2 ruedas autobloccantes Ø 100 mm

RICERCA ED INNOVAZIONE
UNISCONO PRATICITÀ DI UTILIZZO
E DESIGN UNICO, RENDENDO
I NOSTRI ESPOSITORI BELLI
ED INCONFONDIBILI.

RESEARCH AND INNOVATION
COMBINE PRACTICALITY
AND UNIQUE DESIGN,
MAKING OUR DISPLAYERS
BEAUTIFUL AND UNMISTAKABLE.

Piazza Sordello, Mantova

KARETA

COD. 33800057
KARETA DISPLAY

Struttura in ferro verniciata con sterzo rinforzato e blocchi anticaduta, tendina in PVC, porta insegna. L 2600 P 1060 H 2400 mm

.en KARETA DISPLAY

Steel structure painted with reinforced steering and tipping blocks, PVC canopy, price holders. L 2600 W 1060 H 2400 mm

.fr KARETA PRÉSENTOIRE

Structure en fer peint avec le pilotage renforcé et les blocs de protection contre les chutes, PVC rideau, nom du port. L 2600 l 1060 H 2400 mm

.de KARETA DISPLAY

Lackierte Eisenstruktur mit verstärktem Achsschenkel und Anti Überschlagsperrung, PVC-Markise, Werbetafel. L 2600 B 1060 H 2400 mm

.es KARETA EXPOSITOR

Marco de hierro pintado con bloques de dirección de inclinación y reforzado, PVC cortina, muestra de la puerta. L 2600 AN 1060 AL 2400 mm

ARTICOLO ITEM	TIPOLOGIE TYPOLOGIES
COD. 33800057	Vasca PST + ripiano porta vasi (vasi esclusi) PST Tray + vase holder shelf (vases not included)
COD. 33800037	2 ripiani porta vasi (vasi esclusi) 2 vase holder shelves (vases not included)
COD. 33800007	2 Vasche PST (2 PST trays)

PASSIONE E TRADIZIONE

KARETA È LA NOVITÀ TRA I NOSTRI
ESPOSITORI CHE VI OFFRE
LA FUNZIONALITÀ DI SEMPRE
UNITA AL FASCINO DI UN DESIGN
ASSOLUTAMENTE RETRÒ.

PASSION AND TRADITION

KARETA IS OUR NEW DISPLAYER THAT
OFFERS YOU THE FUNCTIONALITY
TOGETHER WITH THE CHARM OF AN
ABSOLUTELY RETRO DESIGN.



VASCHETTA DC IN ABS

Indispensabile per il
mantenimento delle piante
con irrigazione omogenea
grazie al nuovo design.

ABS DC WATER TRAY

Essential for the plant
maintenance with
homogeneous irrigation
thanks to the new design.



COD. 29080007 VASCHETTA IN ABS PER CARRELLO DC

L 1.265 P 555 H 45 mm (scatola 15 pezzi)

.en DC WATER TRAY IN ABS
L 1.265 W 555 H 45 mm (Box 15 pcs)

.fr BAC DC EN ABS
L 1.265 l 555 H 45 mm (Boîte 15 pièces)

.de DC ABS WASSERWANNE
L 1.265 B 555 H 45 mm (Verpackung 15 Stk)

.es BANDEJA DC EN ABS
L 1.265 AN 555 AL 45 mm (Caja 15 piezas)

 Kg 27,28
m³ 0,14



PERCHÉ UTILIZZARE LA VASCHETTA

IRRIGAZIONE: lo scopo primario è quello di irrigare le piante sui carrelli. Le grecature all'interno della vaschetta permettono un'irrigazione sicura perché evitano che la pianta stia a contatto diretto con l'acqua evitando così l'asfissia radicale. **PULIZIA:** l'utilizzo della vaschetta evita lo sgocciolare di acqua e terra sui ripiani sottostanti salvaguardando così la fioritura e la pulizia delle piante. Questa particolarità trova maggior efficacia in presenza di piante fiorite che, se bagnate dall'alto, rischiano di perdere la fioritura. **DESIGN:** da non sottovalutare il valore estetico aggiunto che le vaschette danno al Carrello DC Unistandard, che spesso risulta troppo "essenziale". Le vaschette, con i loro colori e la loro funzionalità, aggiungono un tocco di design all'esposizione sul carrello e facilitano la vendita delle piante.

THE UTILITY OF THE WATER TRAY

IRRIGATION: the main purpose is to irrigate plants on trolleys. The frettings that we've created within the water tray allow a secure irrigation and prevent plants from direct water contact, therefore from asphyxiation. **CLEANNESS:** avoid dripping on shelves protecting plants flowering and keeping them clean. This can be important in presence of blooming plants, that could lose their blossoming, if watered from above. **DESIGN:** the added aesthetic value of water trays, confers to the DC Unistandard Trolley a certain appeal. The multitude of colours as well as their functionality, provide a design touch to trolley's lay out, facilitating plant sales.



OPTIONAL



COD. 520205601270
PANNO UMIDIFICATORE
HUMIDIFYING MEMBRANE

COLORI DISPONIBILI AVAILABLE COLOURS



SMART PACKAGING

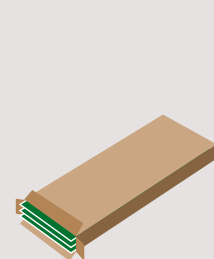

SCATOLA
DA 15 PZ
BOX OF
15 PIECES

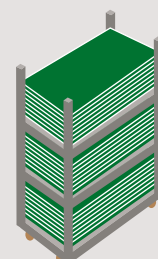

CARRELLO
UNISTANDARD
DA 150 PZ
UNISTANDARD
TROLLEY OF
150 PIECES



IN SCATOLA
SU PALLET
DA 270 PEZZI
BOX ON PALLET
OF 270 PIECES



DETTAGLI DETAILS



IRRIGAZIONE SICURA
SECURE IRRIGATION

MATERIALI RICICLABILI RENEWABLE MATERIALS



ABS+PMMA
Per la nuova Vaschetta
utilizziamo l'ABS+PMMA
che è un materiale plastico
riciclabile.

ABS+PMMA
We use ABS+PMMA for our
new water tray which is a
recyclable plastic material.

**Il sistema che trasforma
il carrello DC in carrello
espositore in 3 passaggi.**

*The kit that transforms the
DC trolley in display trolley
by three steps.*

**INSERIMENTO KIT
KIT INSERTING**

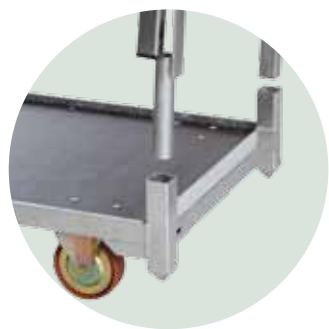

**VASCHETTA DC
WATER TRAY**

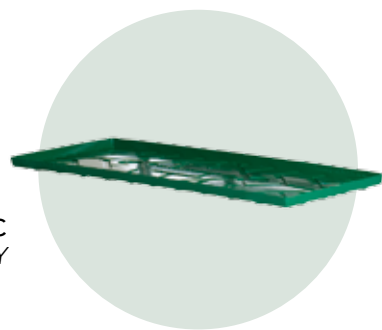

**COD. 33300160
TELAIO KIT MODELLO 160**

**Struttura in ferro zincato composta da 2 montanti laterali + colonne.
Base carrello e ripiani esclusi. L 565 H 1.525 mm**

.en 160 MODEL KIT FRAME

Galvanized iron structure consisting of 2 jambs + columns. Trolley base and shelves not included. L 565 H 1525 mm

.fr KIT STRUCTURE 160

Structure en fer galvanisé composé de 2 montants + colonnes. Chariot et étagères exclus. L 565 H 1525 mm

.de TUFENGESTELL 160

Verzinkte Eisenstruktur mit 2 Seitenständer + Pfosten. Trolley Boden und Regalen nicht enthalten. L 565 H 1.525 mm

.es TELAR KIT 160

Estructura en hierro galvanizado consta de 2 montantes + columnas. Base para carry e bandejas excluidos. L 565 AL 1525 mm

**Kg 25,50
m³ 0,13**



1



2

BREVETTATO PATENTED

**OTTIMA SOLUZIONE
"APRI E CHIUDI" PER
CARRELLO DC.
PRATICO E VELOCE PER
L'ESPOSIZIONE INTERNA
ED ESTERNA.**

*EXCELLENT SOLUTION
"OPEN AND CLOSE"
FOR DC TROLLEY.
EASY & PRACTICAL. FOR
INDOOR AND OUTDOOR.*

3



A

B

i



**AGGANCIO RIPIANO
JOINT FOR SHELF**

PARTICOLARI PARTICULARS

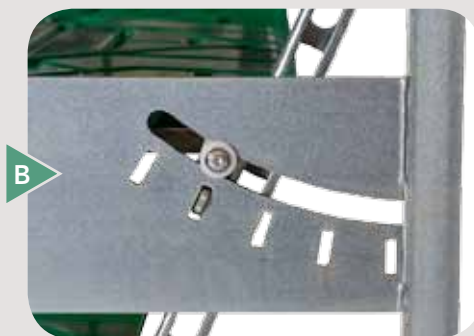

**SISTEMA 5 STADI
5 STEPS SYSTEM**

CARRELLO CABRIOLET 160 CABRIOLET TROLLEY 160

Il Carrello Espositore Cabriolet s'ispira al classico carrello DC unistandard. Con l'aggiunta di un sistema brevettato d'inclinazione a 5 stadi, il carrello riesce a creare facilmente un'esposizione a scala delle piante. Grazie al suo sistema a scatto per l'apertura/chiusura, questo espositore risulta ottimo per chi ha l'esigenza di facili e frequenti spostamenti.

The 160 Cabriolet Trolley Displayer is inspired by the classic DC unistandard cart. With the addition of the patented 5 stages inclination system, the trolley can easily create a "ladder" exposition in a moment. Thanks to its snap system for opening/closing, this displayer is great for anyone who has a need for easy and frequent moves.

VANTAGGI

- 1) Unisce la praticità del carrello DC alla bellezza di un espositore.
- 2) Per aprirlo/chiuderlo sono sufficienti pochissimi secondi, evitando così inutili perdite di tempo.
- 3) Grazie alle ruote robuste può essere spostato tranquillamente come un normale carrello danese.

IDEALE PER ESSERE UTILIZZATO DA:

GARDEN CENTRE E NEGOZI: per tutti coloro che hanno l'esigenza di esporre fuori dal punto vendita, sia esso negozio o Garden Centre, ma che necessitano di un quotidiano ritiro all'interno, il carrello cabriolet è certamente il carrello espositore più adatto. Grazie alla possibilità di aprirlo e chiuderlo in pochi secondi rende rapidi gli spostamenti dall'interno all'esterno e viceversa.

GRANDE DISTRIBUZIONE: il carrello cabriolet è ideale per campagne promozionali. Il suo utilizzo infatti rende rapida e snella l'operatività che dalla zona di scarico passa poi all'esposizione, riducendo l'incidenza della manodopera. Inoltre, con l'esposizione in verticale, viene sfruttato al massimo il rapporto di piante esposte a mq.

Con l'inserimento delle vaschette unistandard a riserva d'acqua, il punto vendita sarà sempre pulito ed ordinato.

AMBULANTI: l'idea nasce proprio dall'applicazione in questo campo per permettere agli operatori di caricare e scaricare il camion in modo rapido e di dedicare il maggior tempo possibile all'aspetto vendita. L'aggiunta della tendina in PVC rende il vostro banco unico e si farà notare in tutte le piazze.

GROSSISTI E RIVENDITORI: la grande particolarità del carrello Cabriolet è quella di utilizzare lo stesso carrello e gli stessi ripiani di quello "danese" unistandard. Questo fattore semplifica e velocizza notevolmente l'operazione di movimentazione dei platò.

ADVANTAGES

- 1) Combines the convenience of DC Carts to the beauty of a displayer
- 2) Open and Close in few seconds. No waste of time.
- 3) Thanks to the strong wheels it can be used as a regular Danish trolley.

IDEAL FOR:

GARDEN CENTRE AND SHOPS: For all those who need to exhibit outdoor and need to move back at the end of the day. The cabriolet is definitive the most appropriate cart. With the ability to open and close it in seconds, it makes the shifts, from inside to outside, an easy and simple task.

RETAILING: Well known and already used in countless occasions, the Cabriolet is ideal for promotional. Easy to handle, from tracks offloading to placing in the sales area, reduces labor costs. Besides, with the vertical exposure, the ratio of plants exposed to mq., is optimal. With adding the unistandard water trays, the store will always be clean and tidy.

VENDORS: The idea comes right from these users that need to load and unload their trucks quickly and use time to sell instead to handle materials. The addition of the PVC canopy makes the exhibition unique and will create a magic atmosphere.

WHOLE SALERS: The great particularity of the Cabriolet is that it uses the same bases and shelves as the Danish carts. This factor simplifies any handling operation. The measurements fit, anytime, anywhere, even on half size carts.



APERTO
OPENED



CHIUSO
CLOSED

COD. 33340160 CARRELLO CABRIOLET 160

Struttura in ferro zincato con sistema di inclinazione a 5 stadi.

Carrello composto da:
Base, telaio kit, 4 ripiani, 4 vaschette
Aperto L 1.350 P 1.265 H 1.570 mm
Chiuso L 1.350 P 565 H 1.645 mm

.en CABRIOLET TROLLEY 160
Iron structure with galvanized 5 level tilt system.
Cart consisting of: Base, frame kit, 4 shelves.
Open L 1350 W 1265 H 1570 mm
Closed L 1350 W 565 H 1645 mm

.fr CABRIOLET VERKAUFSSTÄNDER 160
Système de fer galvanisé incliner de 5 étapes.
Chariot constitué par:
base, kit cadre, 4 étagères, 4 vasques
Ouvert L 1350 l 1265 H 1570 mm
Fermé P 565 l 1350 H 1645 mm

.de CABRIOLET VERKAUFSSTÄNDER 160
Lackierte Eisenstruktur mit 5 stufiger Neigungssystem.
Der Verkaufsständer besteht aus: Boden, Stufengestell,
4 Regale, 4 Wasserwannen. Offen L 1.350 B 1.265 H
1.570 mm. Geschlossen L 1.350 B 565 H 1.645 mm

.es CABRIOLET CARRO 160
Estructura de hierro galvanizado con sistema de inclinación en 5 posiciones.
Incluye:
Base, telar kit, 4 rellanos, 4 bandejas
Abierto L 1.350 An. 1.265 Al. 1.570 mm
Cerrado L 1.350 An. 565 Al. 1.645 mm

Kg 79,00
m³ 0,60



SEMICABRIOLET TROLLEY



OPTIONAL



COD. 532405550630 VASCHETTA
COD. 532405550630 WATER TRAY

COD. 33350160
CARRELLO CABRIOLET 160
CON TENDINA

Struttura in ferro zincato con sistema di inclinazione a 5 stadi completo di tendina regolabile.

Carrello composto da:

Base, telaio kit, 4 ripiani, 4 vaschette e tendina

Aperto L 1.395 P 1.465 H 2.245 mm

Chiuso L 1.395 P 565 H 2.245 mm

.en CABRIOLET TROLLEY 160 WITH CANOPY

Is made of galvanized iron frame with 5 steps inclination system and adjustable Canopy. The cart: Base, frame kit, 4 shelves, trays and curtain. Open L 1395 W 1465 H 2245 mm Closed L 1395 W 565 H 2245 mm

.fr CHARIOT CABRIOLET 160 AVEC RIDEAU

Système de fer galvanisé incliner de 5 étape avec rideau Chariot constitué par: base, kit cadre, 4 étagères, 4 vasques et rideau. Ouvert L 1395 l 1465 H 2245 mm Fermé L 1395 l 565 H 2245 mm

.de CABRIOLET VERKAUFSTÄNDER 160 MIT DACHMARKISE

Lackierte Eisenstruktur mit 5 stufiger Neigungssystem und höhenverstellbarer Dachmarkise. Der Verkaufsstander besteht aus: Boden, Stufengestell, 4 Regale, 4 Wasserwannen und Dachmarkise.

Offen L 1.395 B 1.465 H 2.245 mm.

Geschlossen L 1.395 B 565 H 2.245 mm

.es CABRIOLET CARRO 160 CON TOLDO

Estructura de hierro galvanizado con sistema de inclinación en 5 posiciones, con toldo.

Incluye: Base, telar kit, 4 rellanos, 4 bandejas.

Abierto L 1395 An. 1465 Al. 2245 mm

Cerrado L 565 An. 1395 Al. 2245 mm

 **Kg 93,80**
m³ 0,60



APERTO
OPENED



COD. 36005417
TENDINA IN PVC CON SUPPORTO

.en PVC CANOPY WITH SUPPORT

.de PVC MARKISE MIT GESTELL

.fr RIDEAU EN PVC AVEC SUPPORT

.es TOLDO EN PVC CON SUPORTE

DETTAGLI DETAILS



APERTURA/CHIUSURA
OPENING/CLOSING

COLORI DISPONIBILI
AVAILABLE COLOURS



VISUAL MERCHANDISING



CHIUSO
CLOSED

COD. 33600302
BANCALE SALVASPAZIO CON VASCHETTA ABS

Supporto altezza regolabile, 4 ruote girevoli di cui 2 autobloccanti (1 scatola 3 pz). Zincato. L 1.270 P 580 H 500/900 mm.

.en SAVING-SPACE TABLE WITH ABS WATER TRAY

Adjustable height support, 4 swiveling wheels of which 2 swivel casters self-locking (1 Box 3 pcs). L 1.270 W 580 H 500/900 mm. Galvanized.

.fr TABLE ÉPARGNE-ESPACE AVEC VASQUE ABS À RÉSERVE D'EAU

Hauteur réglable, 4 roues pivotantes de 2 verrouillage (1 Boîte 3 pièces) L. 1.270 l. 580 h. 500/900 mm. Galvanisé.

.de "RAUMSPARENDER"-VERKAUFSTÄNDER MIT ABS WASSERWANNE

Höhenverstellbares Gestell, 4 drehbare Rollen, 2 von den mit Bremse (1 Kiste 3 Stk). L 1.270 B 580 H 500/900 mm. Verzinkt.

.es MESA ABORRO-ESPACIO CON BANDEJA ABS PARA GUARDAR EL AGUA

Altura regulable, 4 ruedas giratorias con 2 ruedas autobloccantes (1 Caja 3 piezas) L 1.270 An. 580 Al. 500/900 mm. Galvanizado.



ESPOSITORI A ISOLA

Singolo o doppio in alluminio con vaschette a riserva d'acqua, ultimo piano regolabile in altezza ed estraibile 4 ruote girevoli di cui 2 autobloccanti in gomma Ø 100 mm.

.en ISLAND DISPLAYER

Single or double in aluminium frame with water trays, removable shift top level shelf with adjustable height, 4 swiveling wheels of which 2 swivel casters self-locking, Ø 100 mm

.fr PRÉSENTOIRS A ÎLE

Individuelle ou double structure en aluminium avec vasques, hauteur réglable du rayon supérieur et extractible, 4 roues pivotantes de 2 verrouillage, Ø 100 mm

.de FREISTEHENDER VERKAUFSSTÄNDER

Einzel oder Doppel, aus Aluminium mit Wasserwannen, die oberste Etage ist ausziehbar und höhenverstellbar. Gummirollen: 4 drehbare Rollen, 2 von den mit Bremse Ø100 mm

.es EXPOSITORES ISLA

Singulo o doble expositor en aluminio con bandejas, altura rellano superior regulable y estraible, 4 ruedas giratorias con 2 ruedas autoblocantes Ø 100 mm

MISURE / DIMENSIONS

COD. 33151001	L 1270 P 1670 H 1380/1680 mm
COD. 33152001	L 2540 P 1670 H 1380/1680 mm



Kg 41,00
m³ 0,52



Kg 56,00
m³ 0,70



ESPOSITORI A MURO

Singolo o doppio in alluminio con vaschette a riserva d'acqua, ultimo piano regolabile in altezza ed estraibile 4 ruote girevoli di cui 2 autobloccanti in gomma Ø 100 mm.

.en WALL DISPLAYER

Single or double in aluminium frame with water trays, removable shift top level shelf with adjustable height, 4 swiveling wheels of which 2 swivel casters self-locking, Ø 100 mm

.fr PRÉSENTOIRS MURAL

Individuelle ou double structure en aluminium avec vasques, hauteur réglable du rayon supérieur et extractible, 4 roues pivotantes de 2 verrouillage, Ø 100 mm

.de WANDVERKAUFSSTÄNDER

Einzel oder Doppel, aus Aluminium mit Wasserwannen, die oberste Etage ist ausziehbar und höhenverstellbar. Gummirollen: 4 drehbare Rollen, 2 von den mit Bremse Ø100 mm

.es EXPOSITORES DE PARED

Singulo o doble expositor en aluminio con bandejas, altura rellano superior regulable y estraible, 4 ruedas giratorias con 2 ruedas autoblocantes Ø 100 mm

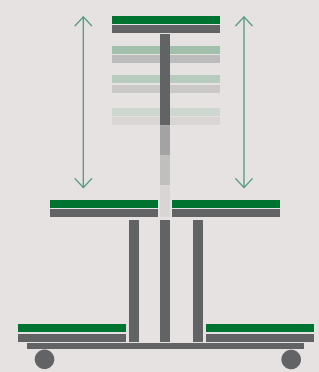

ALTEZZA REGOLABILE CON PIANO ESTRAIBILE
REMOVABLE SHIFT TOP LEVEL SHELF WITH ADJUSTABLE HEIGHT

OPTIONAL



PANNO UMIDIFICATORE
HUMIDIFYING MEMBRANE

MISURE / DIMENSIONS

COD. 33131001	L 1270 P 1130 H 1380/1680 mm
COD. 33132001	L 2540 P 1130 H 1380/1680 mm

Kg 27,50
m³ 0,38

Kg 39,00
m³ 0,47





COD. 34010302
BANCARELLA PIEGHEVOLE A 3 RIPIANI

Pratica, maneggevole, economica. Una volta chiusa può essere riposta in qualsiasi spazio grazie al suo minimo ingombro. Ottimo espositore per gli ambulanti.
L 1.700 P 950 H 900 mm (aperta) - Ripiano L 1.660 P 300 mm

.en 3 SHELVES FOLDING DISPLAY STAND

Handy, easy to handle, cheap. Once closed you can put it everywhere thanks to its small dimensions. Great displayer for hawkers.

L 1.700 W 950 H 900 mm (opened) - Shelf L 1.660 W 300 mm

.fr ÉTAL PLIANTE À 3 ÉTAGÈRES

L. 1.700 l. 950 h. 900 mm (ouverte). Étagère L. 1.660 l. 300 mm

.de 3 STUFEN ZUSAMMENKLAPPBARER VERKAUFSSTÄNDER

L 1.700 B 950 H 900 mm (open)

Etage L 1.660 B 300 mm

.es EXPOSITOR PLEGABLE 3 RELLANOS

L 1.700 An. 950 Al. 900 mm (abierto)

Rellano L 1.660 An. 300 mm

 Kg 22,50
m³ 0,09

DETTAGLI DETAILS



BANCARELLA CHIUSA
CLOSED DISPLAY STAND

OPTIONAL



PANNO UMIDIFICATORE
HUMIDIFYING MEMBRANE



COD. 34010402
BANCARELLA PIEGHEVOLE A 4 RIPIANI

Pratica, maneggevole, economica. Una volta chiusa può essere riposta in qualsiasi spazio grazie al suo minimo ingombro. Ottimo espositore per ambulanti. L 1.700 P 1350 H 1050 mm (aperta)
Ripiano L 1.660 P 300 mm

.en 4 SHELVES FOLDING DISPLAY STAND

Handy, easy to handle, cheap. Once closed you can put it everywhere thanks to its small dimensions. Great displayer for hawkers.

L 1.700 W 1350 H 1050 mm (opened)
Shelf L 1.660 W 300 mm

.fr ÉTAL PLIANTE À 4 ÉTAGÈRES

L. 1.700 l. 1350 h. 1050 mm (ouverte)

Étagère L. 1.660 l. 300 mm

.de 4 STUFEN ZUSAMMENKLAPPBARER VERKAUFSSTÄNDER

L 1.700 B 1350 H 1050 mm (open) - Etage L 1.660 B 300 mm

.es EXPOSITOR PLEGABLE 4 RELLANOS

L 1.700 An. 1350 Al. 1050 mm (abierto)

Rellano L 1.660 An. 300 mm



 Kg 30,00
m³ 0,12

COD. 29096017
VASCHETTA PER BANCARELLA

Per irrigazione piante.
In plastica ABS colore verde - L 1.660 P 310 H 40 mm

.en WATER TRAY FOR DISPLAY STAND

To irrigate plants, made of green ABS.

L 1.660 W 310 H 40 mm

.fr VASQUE POUR ÉTAL

L 1.660 l. 310 h. 40 mm

.de WASSERWANNE FÜR VERKAUFSSTÄNDER

L 1.660 B 310 H 40 mm

.es BANDEJA PARA EXPOSITOR

L 1.660 An. 310 Al. 40 mm

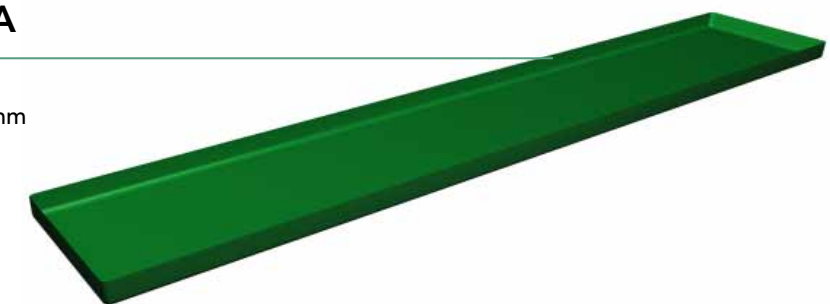

COD. 34020027
CARRETTINO ESPOSITORE

Struttura in ferro zincata e verniciata di colore bianco, 2 vaschette verdi e tendina PVC bianco/verde. L 1.400 P 780 H 2.050 mm

.en **DISPLAY TROLLEY**

White coloured iron frame, 2 green water trays and PVC white/green canopy. L 1.400 W 780 H 2.050 mm

.fr **CHARIOT PRÉSENTOIR**

Structure en fer vernie en blanc, 2 vasques étanches vertes et rideau PVC blanc/vert. L 1.400 l 780 H 2.050 mm

.de **DEKO-VERKAUFSWAGEN**

Weißlackierte feuerverzinkte Eisenstruktur, 2 grüne Wasserwannen und PVC weiß/grüne Dachmarkise. L 1.400 B 780 H 2.050 mm

.es **CARRITO EXPOSITOR**

Estructura de hierro barnizada a fuego (blanca), 2 bandejas verdes y toldo PVC blanco/verde. L 1.400 AN 780 AL 2.050 mm

 Kg 36,00
m³ 0,37



**ALTRA TIPOLOGIA
DISPONIBILE**
OTHER TYPOLOGY
AVAILABLE

COD. 34020037

COD. 34041303
ESPOSITORE RONDÒ

Struttura verniciata di colore bianco con 13 vasi lt 4 (Ø 160 H 260 mm) - L 600 P 600 H 1.370 mm

.en **RONDÒ DISPLAYER**

White painted iron frame with 13 vases lt 4 (Ø 160 H 260 mm) L 600 W 600 H 1.370 mm

.fr **PRÉSENTOIR RONDÒ**

Structure vernie en blanc avec 13 vases lt 4 (Ø 160 h. 260 mm) L. 600 l. 600 h. 1.370 mm

.de **RONDÒ SCHNITTBLUMEN-VERKAUFSSTÄNDER**

Weißlackiertes Gestell mit 13 Vasen lt 4 (Ø 160 H 260 mm) L 600 B 600 H 1.370 mm

.es **EXPOSITOR RONDÒ**

Estructura barnizada en blanco con 13 cubetas lt 4 (Ø 160 Al. 260 mm) - L 600 An. 600 Al. 1.370 mm

 Kg 9,00
m³ 0,17



ESPOSITORI FLORA

Struttura in ferro zincata e verniciata con vasi in plastica.

.en **FLORA DISPLAYER**

Coloured frame with plastic vases.

.fr **PRÉSENTOIR FLORA**

Structure vernie avec vases en plastique.

.de **FLORA VERKAUFSSTÄNDER**

Lackiertes Gestell mit Kunststoff-Vasen.

.es **EXPOSITOR FLORA**

Estructura barnizada con cubetas de plástico.

ARTICOLO ITEM		VASI VASES	DIMENSIONI DIMENSIONS
COD. 34040223	FLORA 2	2 x Lt.10 (Ø 260 H 270 mm)	L 665 P 150 H 630 mm
COD. D4403031	FLORA 3	3 x Lt.10 (Ø 260 H 270 mm)	L 580 P 580 H 830 mm
COD. 34040323	FLORA 2+1	3 x Lt.10 (Ø 260 H 270 mm)	L 700 P 480 H 1450 mm

FLORA 2  Kg 3,40
m³ 0,09



FLORA 3  Kg 5,00
m³ 0,06



FLORA 2+1  Kg 3,62
m³ 0,09

COD. 34041901
ESPOSITORE FLORA 18

Struttura in ferro zincata e verniciata di colore bianco, pieghevole, con 9 vasi (Ø 170 H 350 mm) e 9 vasi (Ø 180 H 450 mm) e tendina.
Optional: ruote Ø 100 mm L 1.400 P 1.000 H 2.050 mm

.en DISPLAYER FLORA 18

White painted iron frame, folding, with 9 vases (Ø 170 H 350 mm), 9 vases (Ø 180 H 450 mm), canopy. Optional: wheels Ø 100 mm - L 1.400 W 1.000 H 2.050 mm

.fr PRÉSENTOIR FLORA 18

Structure vernie en blanc, pliant, avec 9 vases (Ø 170 h. 350 mm), 9 vases (Ø 180 h. 450 mm), rideau. Optional: roues Ø 100 mm - L 1.400 l 1.000 H 2.050 mm

.de BLUMENVERKAUFSTÄNDER FLORA 18

Weißlackierte Eisenstruktur, klappbar, mit 9 Vasen (Ø 170 H 350 mm), 9 Vasen (Ø 180 H 450 mm), Dachmarkise. Extra: Rollen Ø 100 mm - L 1.400 B 1.000 H 2.050 mm

.es EXPOSITOR FLORA 18

Estructura barnizada en blanco, plegable, con 9 cubetas (Ø 170 AL 350 mm), 9 cubetas (Ø 180 AL 450 mm), toldo. Optional: ruedas Ø 100 mm - L 1.400 AN 1.000 AL 2.050 mm

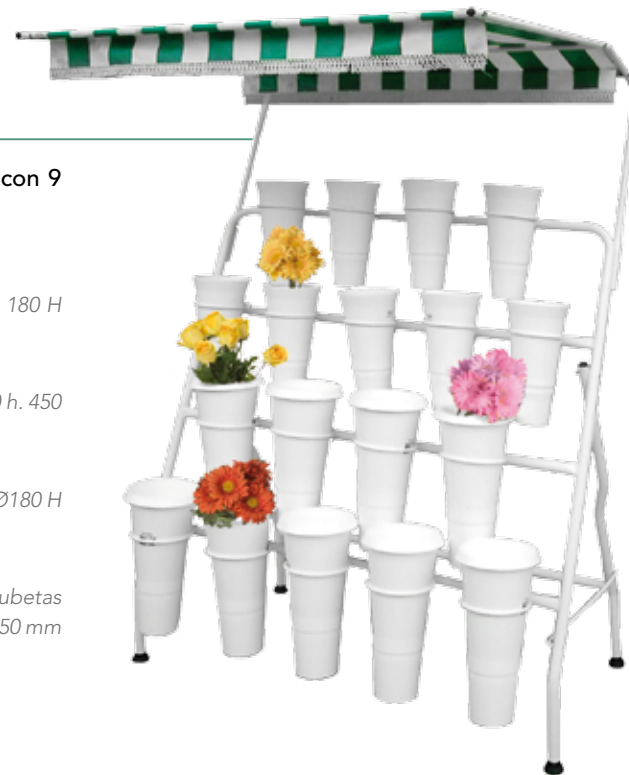

OPTIONAL



COD. 34660070
ESPOSITORE GOCCIA

Espositore a 3 ripiani per piante, fiori e oggettistica.
Struttura in tubolare e lamiera piegata verniciata.
Completo di ripiani regolabili, ruote Ø 100 mm e porta grafica regolabile. L 940 P 740 H 1350.

.en GOCCIA DISPLAYER

3 shelves exhibitor for plants, flowers and accessories.
Tubular frame and folded metal sheet, painted waterproof.
Complete with adjustable shelves, castors Ø 100 mm and adjustable graphics frame. L 740 W 940 H 1350.

.fr PRÉSENTOIR GOCCIA

Présentoir avec 3 étagères pour plantes, fleurs et cadeaux.
Structure en feuille tubular Complet avec étagères réglables,
roues ø 100 mm et support graphique réglable
L 940 l 740 H 1350

.de VERKAUFSTÄNDER GOCCIA

3-stufiger Verkaufständer für Pflanzen, Blumen und Dekorationen.
Lackierte Eisenstruktur, geeignet für Außen.
Mit regulierbaren Regalen, Rollen Ø 100 mm und regulierbarer
Werbefel. L 940 B 740 H 1350

.es EXPOSITOR GOCCIA

Expositor con 3 rellanos para plantas, flores y regalos.
En chapa y tubular pintada. Completa con rellanos regulables,
ruedas Ø 100 mm y mostrar portagráfiche regulables.
L 940 AN 740 AL 1350



Julia Wood Line è la prima linea di espositori per piante e fiori realizzata in legno progettata da ORGANIZZAZIONE ORLANDELLI.

Julia Wood Line is the first wooden line of displays for plants and flowers made by ORGANIZZAZIONE ORLANDELLI

COD. 48020003
ESPOSITORE A 3 GRADONI

In legno listellare a tre strati certificato PEFC.
Piedini Ø 80 mm regolabili. L 1110 P 990 H 765 mm

.en THREE-STEPS WOODEN DISPLAYER
Lamellar wood triple-layered, PEFC certificate. Ø 80 mm adjustable feet. L 1110 W 990 H 765 mm

.fr PRESENTOIR À 3 ÉTAGÈRES
En lattes de bois certifié PEFC. Petit pieds réglables. Ø 80 mm. L 1110 l 990 H 765 mm

.de DREISTUFIGER HOLZVERKAUFSTÄNDER
PEFC zertifiziertes 3-Schicht Lamellenholz.
Regulierbare Füßchen Ø 80 mm. L 1110 B 990 H 765 mm

.es EXPOSITOR EN 3 PASOS
Listones de madera con tres capas PEFC certificados.
Ø 80 mm pies regulables. L 1110 AN 990 AL 765 mm

Questo espositore di Julia Wood Line è caratterizzato da un'estrema versatilità che permette di utilizzarlo contemporaneamente sia per esporre piante in vaso che fiori recisi. La struttura è stata infatti studiata per organizzare le tre casse di contenimento in due posizioni differenti. Julia wood line utilizza una struttura interamente in legno lamellare a tre strati verniciato che garantisce robustezza e durata nel tempo. La struttura dell'espositore è dotata di piedi snodati e regolabili che permettono un facile livellamento ed evitano il contatto diretto tra la struttura in legno e la pavimentazione.

This displayer of Julia Wood Line is characterized by an extreme versatility that allows you to use simultaneously to display both potted plants and cut flowers. The structure was in fact designed to organize the three containing boxes in two different positions. Julia wood line uses a completely three-layer painted laminated wood that provides strength and durability. The structure of the displayer has articulated and adjustable feet that allow an easy leveling and avoid the direct contact between the wooden structure and the floor.



VISUAL MERCHANDISING



WE

L'Organizzazione Orlandelli da 30 anni opera nel settore florovivaistico proponendo prodotti da sempre innovativi nei sistemi di movimentazione ed esposizione di piante e fiori. Il nostro Staff è in viaggio ogni giorno per visitare aziende, incontrare persone, partecipare ad appuntamenti fieristici al fine di soddisfare ogni singola richiesta della clientela Nazionale ed Internazionale. Nell'accogliente Showroom presso la nostra sede, appositamente allestito in una serra, i prodotti in esposizione sono abbelliti con fiori e piante creando così una sensazione di ambientazione reale. Anche nel mondo WEB, Organizzazione Orlandelli ha voluto essere all'avanguardia creando un sito internet dinamico e completo nel quale è possibile acquistare online i nostri prodotti con la garanzia della qualità Orlandelli. La divisione Ricerca & Sviluppo affianca la clientela offrendo la massima disponibilità e professionalità, ascoltando per consigliare al meglio ogni singola esigenza sulla base di esperienza e competenza ad alti livelli. La nostra Mission è garantire un'eccellente qualità del Servizio al Cliente, dove responsabilità e qualità dei rapporti interpersonali sono il terreno fertile del nostro lavoro.

Organizzazione Orlandelli from 30 years has been engaged in the floricultural industry by offering innovative products in handling and displaying systems of plants and flowers. Our Staff is on the road every day to visit Companies, meet people, and participate on trade fairs in order to satisfy each customer's request Nationally and Internationally.

In our cosy Showroom, set up purposely in a greenhouse, the displayed products are decorated with flowers and plants creating a feeling of a real setting. Even in the world of the WEB, Organizzazione Orlandelli wanted to be at the forefront by creating a dynamic and complete website where you can buy our products online with Orlandelli's quality guarantee. The Research & Development department supports the customers by offering the maximum availability and professionalism, by listening every single need to give the better suggestions based on high level experience and know-how. Our Mission is to guarantee excellent quality Customer Service, where responsibility and quality of interpersonal relationships are the fertile soil of our work.

Organizzazione Orlandelli srl

COME RAGGIUNGERCI HOW TO REACH US

Organizzazione Orlandelli è localizzata in un importante crocevia di rotte stradali, tra le province di Cremona, Parma e Verona. La nostra zona è servita da ben 5 aeroporti ai quali fanno capo molte compagnie aeree, per cui le possibilità per venire a visitare la nostra azienda sono davvero tante. Mantova è una zona molto attiva a livello vivaistico perché a pochi km si trova Canneto sull'Oglio, distretto produttivo leader in Europa per la produzione di piante ad alto fusto.

Organizzazione Orlandelli is strategically situated near the province of Cremona, Parma and Verona. There are 5 airports where the most famous airline companies land, giving you the opportunity to visit us. Mantova is a very important region for Garden Centres, few kilometres away from Canneto sull'Oglio, a European leader in long stem plants production.

MILANO LINATE www.sea-aeroportimilano.it / MILANO BERGAMO www.sacbo.it
VERONA www.aeroportoverona.it / BOLOGNA www.bologna-airport.it / PARMA www.parma-airport.it

NOTE. Le informazioni tecniche contenute nel presente catalogo potrebbero subire delle variazioni. Le immagini sono dimostrative del prodotto e non sono vincolanti ai fini commerciali. Organizzazione Orlandelli s.r.l. non si assume alcuna responsabilità sull'idoneità di alcuni prodotti per specifiche applicazioni escluse quelle che non siano state espressamente concordate per iscritto per singoli casi.

NOTES. The technical features introduced in this catalogue could vary. The pictures are indicative but they are not binding. doesn't undertake any responsibility for the suitability of certain products that get modified because required by the customer for a specific application. The responsibility won't be undertaken, unless expressly written.

No

CATALOGUE

BANCALI ESPOSITORI
DISPLAYING TABLES

1

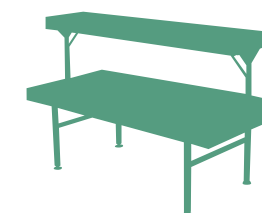

CARRELLI
TROLLEYS

2

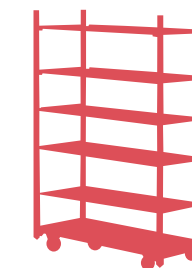

ARREDAMENTO
FURNITURE

3

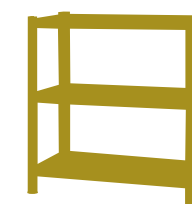

SOFTWARE AREE VERDI
LANDSCAPE SOFTWARE

4



we ♥ green

Viviamo in un'epoca in cui la salvaguardia dell'ambiente dovrebbe essere una preoccupazione per ciascuno di noi. Da tempo la nostra azienda si è attivata per contribuire in maniera significativa a preservare gli equilibri dell'ecosistema. Partendo dall'analisi attenta nella scelta e nell'utilizzo dei materiali passando dalla selezione scrupolosa dei fornitori e delle migliori tecnologie reperibili, produciamo ed imballiamo i nostri prodotti secondo i disciplinari ecosostenibili. È facilmente verificabile che le risorse investite in questa direzione hanno un fondamento reale. Tutti i marchi che vedete in questa pagina sono riportati sui nostri prodotti ed imballaggi a reale dimostrazione di un impegno concreto nel rispetto dell'ambiente.

We live in an age where the environmental protection should concern every one. Our company contributes significantly to maintain the equilibrium of the ecosystem. Starting from the careful analysis in the choice and the use of prime materials, selecting eco oriented and liable suppliers and using the best available technologies, we produce and pack our products according to eco sustainable disciplinary norms. It is easily verifiable that the resources invested in this direction have a real basis. All the brands that you see on this page are listed on our products and the packagings are to demonstrate a real commitment in respect of the environment.

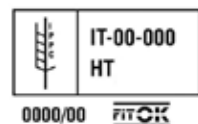

PROJECT MANAGEMENT

Entergreen Team

GRAPHIC DESIGN



silvia.malavasi@gmail.com

PRINT

Arti Grafiche Castello - Viadana MN

PAPER

spazio per certificazione carta

ORGANIZZAZIONE 
ORLANDELLI | **30°**
1983 / 2013

Mantova (ITALY) **T** +39.0376.960311
F +39.0376.960303 **E** info@orlandelli.it

www.orlandelli.it *we*  *green*

